

KLT-IRSW-OS02C10 V1.2

5MP OmniVision OS02C10 IR Switch MIPI Interface Fixed Focus Camera Module

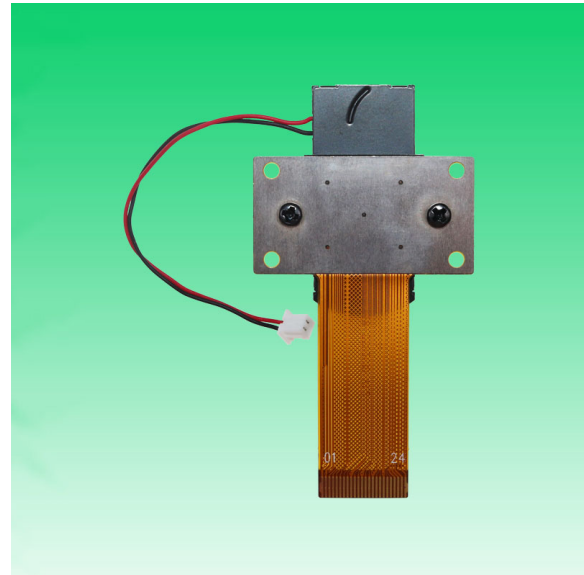
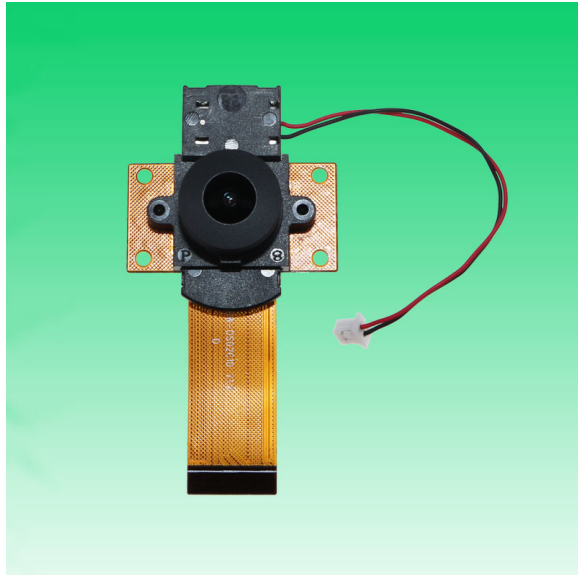

Camera Module No.	KLT-IRSW-OS02C10 V1.2
Resolution	5MP
Image Sensor	OS02C10
Sensor Type	1/2.8"
Pixel Size	2.9 um x 2.9 um
EFL	1.75 mm
F.NO	2.00
Pixel	1920 x 1080
View Angle	200.0°(DFOV) 200.0°(HFOV) 100.0°(VFOV)
Lens Dimensions	16.20 x 16.10 x 12.82 mm
Module Size	56.47 x 30.00 mm
Module Type	Fixed Focus
Lens Model	KLT-LENS-TRC-4175A6
IR Switch Input Voltage	3.3V - 5.5V
Lens Filter IR Frequency	645nm +/- 15nm
Lens Filter AR Frequency	700nm - 1,000nm
Operation (IR Day Time)	Red Line: Negative Black Line: Positive
Operation (AR Night Time)	Red Line: Positive Black Line: Negative
IR Switch Connector	962-10231-030005 (2 Pin)
Interface	MIPI
Operating Temperature	-30°C to +85°C
Mating Connector	FH12-24S-0.5SH

**KLT-IRSW-OS02C10 V1.2****5MP OmniVision OS02C10 IR Switch MIPI Interface Fixed Focus Camera Module**

Top View



Side View

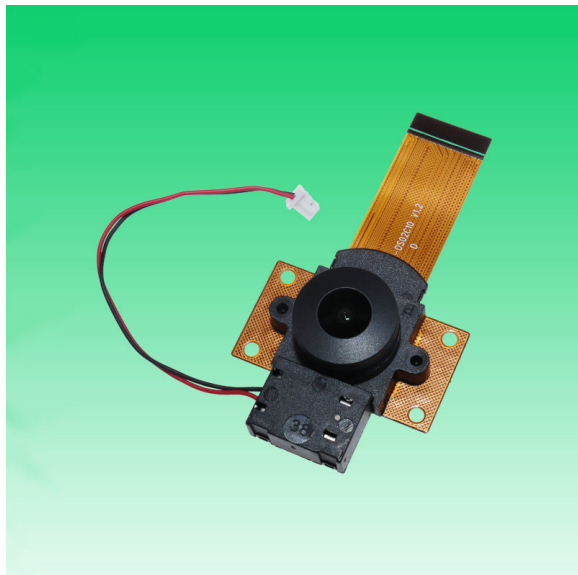

Bottom View

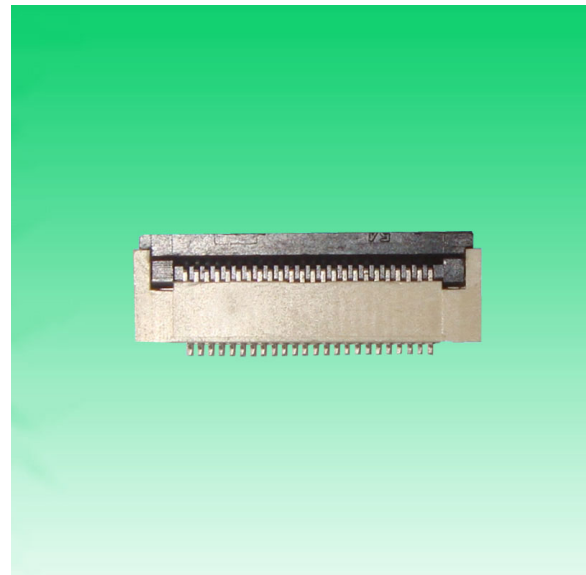

Mating Connector

ROHS

PIN SIGNAL

1	AGND
2	AVDD2.8V
3	SDA
4	SCL
5	PWDN
6	RST/XSHUNDN
7	MCP
8	MCN
9	DGND
10	MDP0
11	MDN0
12	DGND
13	MDP1
14	MDN1
15	DGND
16	MDP2
17	MDN2
18	DGND
19	MDP3
20	MDN3
21	DGND
22	DVDD1.1V
23	DOVDD1.8V
24	MCLK

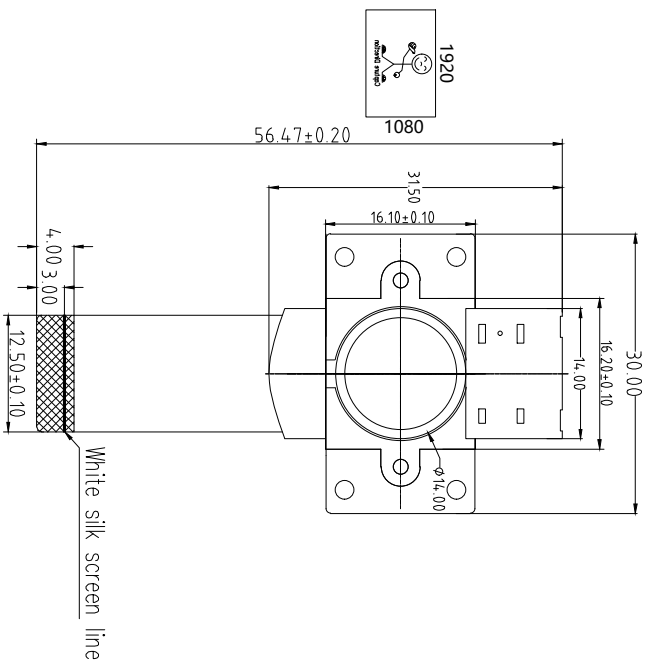

TOP VIEW

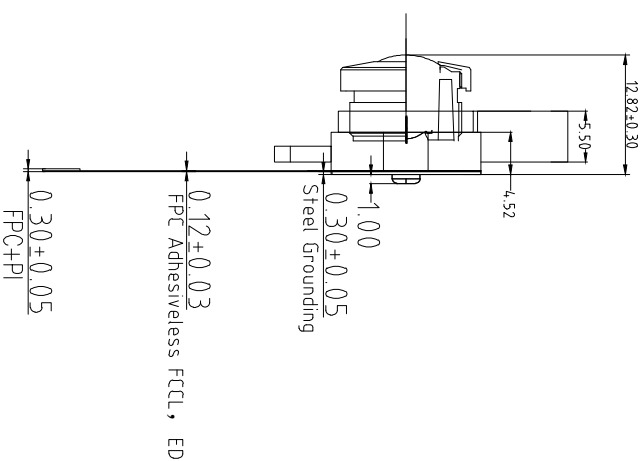

SIDE VIEW

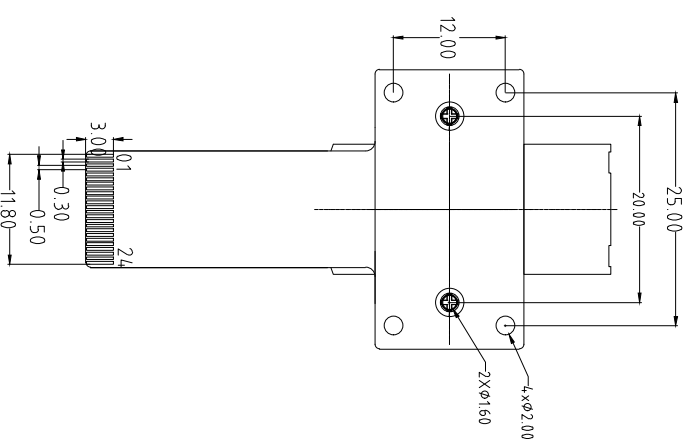

BOTTOM VIEW

NOTE:
1.The device slave
address:0x6C(w);0x6D(r)

Parameter:

1、Sensor specification:

Image Sensor: OS02C10
Pixel: 2.9umx2.9um
Lens Type: 1/2.8
Important Voltage Description: DVDD1.1V
(external power supply);

2、Lens specification:

FOV: 200°(D);200°(H);100°(V)
F/NO.: 2.0
TV distortion: <-35.9%
Focal length: 1.75mm
Composition: 2G4P+IR Switch

Kai Lap Technologies Group Ltd

Designed By	Kevin	Model Name:	KLT-IRSW-OS02C10 V1.2
Checked By	Aouly	Projection Type:	Third Angle
		Unit:	mm
		Material:	-----
		Scale:	1:1
		Sheet:	1 of 1
		Version:	1/0

Version	Information	Date
V1.0	First Version	3-2-2019
V1.2	Change lens and IR cut	5-31-2021



Lens Model: KLT-LENS-TRC-4175A6

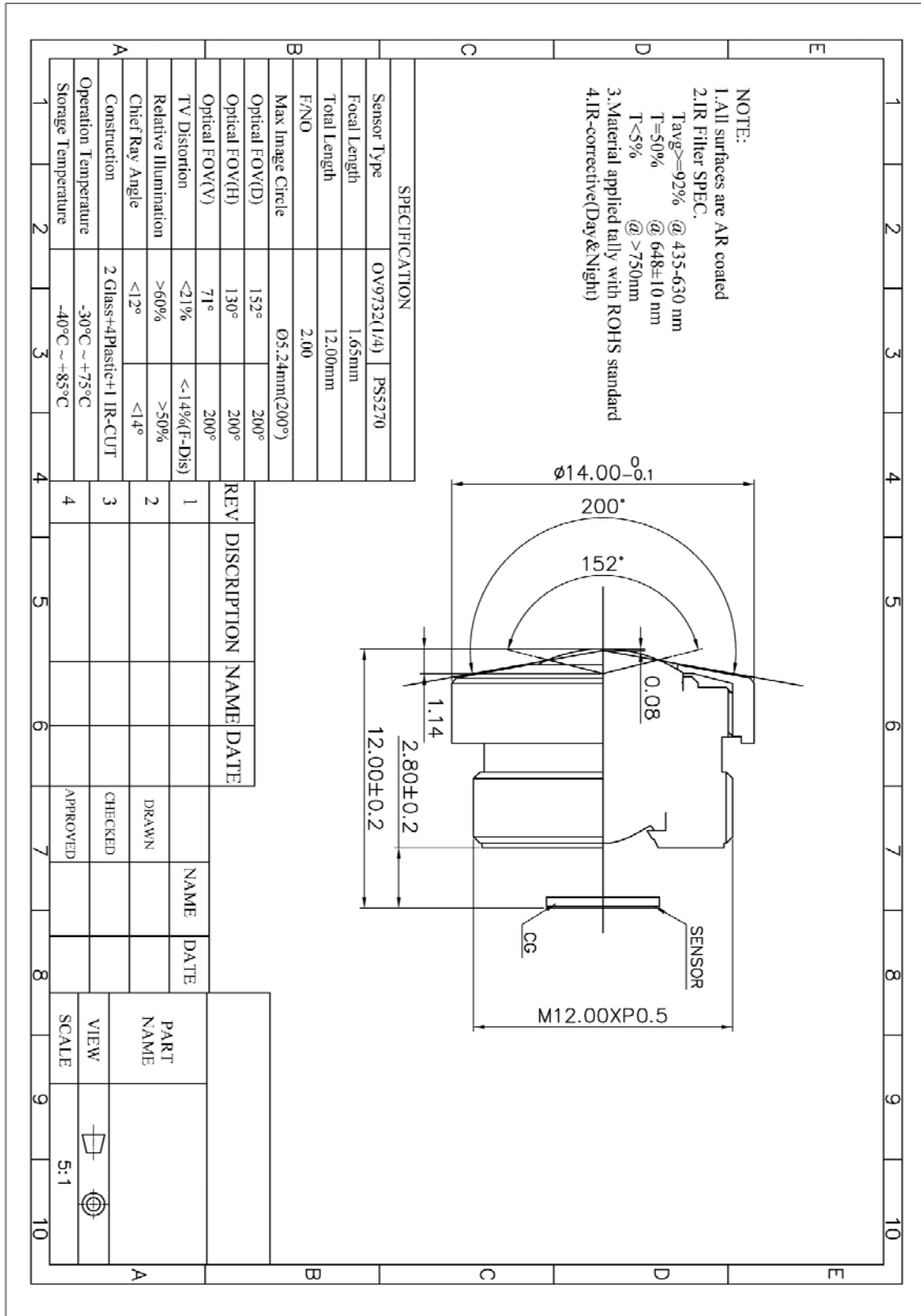

0.5mm and 1mm Pitch Connectors For FPC/FFC

FH12 Series

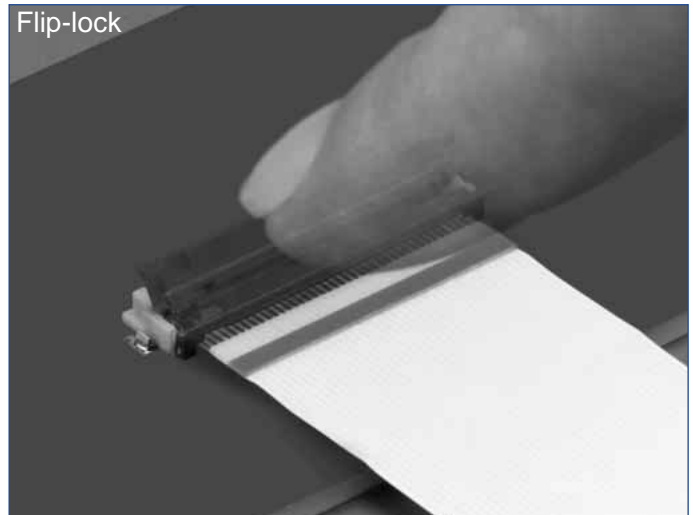
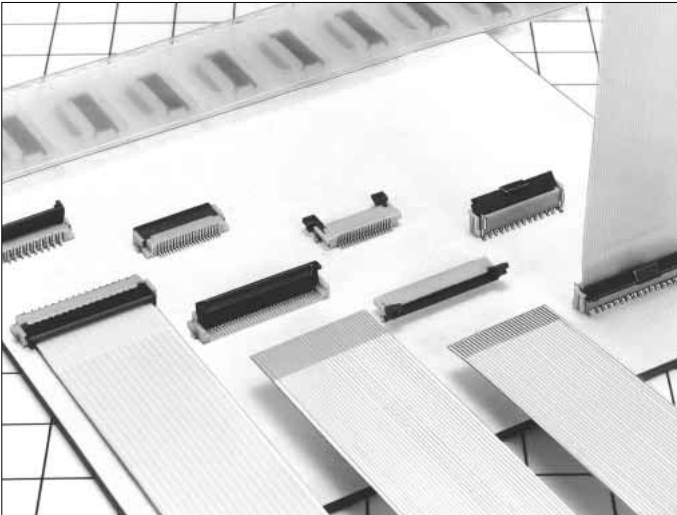

■ Features

1. Ease of Use and Space Savings

Only one finger or 6.9N (Newtons) of force is required to lock Hirose's rotational actuator (flip-lock) as compared to using 2 fingers and 39.2N to close a FFC/FPC connector from our competition.

The Flip-Lock design also allows customers to place 2 or more connectors side by side as there is no need to waste additional board space for a side latch.

2. Strengthened Flip-lock Actuator

The standard Flip-Lock requires only 2.0mm height above the board. A strengthened lock lever is available which only requires an additional 0.4mm.

3. Supports Thin FPC (0.18mm)

Hirose does not require double-sided FPC to have any additional strengthening plate or stiffener and can therefore support a thickness of as little as 0.18mm +/- 0.05.

4. Hirose Ensures Reliability

Hirose's patented half tuning fork contacts maintain the required normal force without relying on the connector housing. With our competitor's conventional products the housing walls support the contact force, which does not provide for long-term reliability.

5. Prevention of Solder Bridge

Excess solder cavity absorbs excessive solder and avoids solder bridging.

6. Three different assembly types

FH12 is offered in Top & Bottom Contact and Vertical Mount and offered in both a 0.5mm contact pitch as well as a 1.0mm contact pitch (bottom contact only).

■ Applications

Notebook computers, printers, PDAs, digital cameras and other compact devices for interconnecting the main circuit board with the LCD, HDD or other device.

Rotating One-touch Mechanism

①

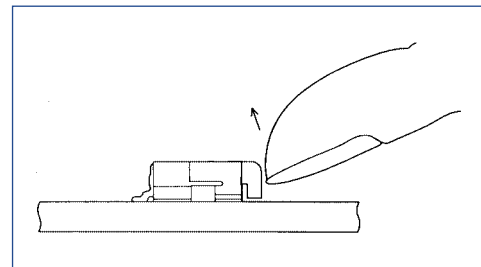

②

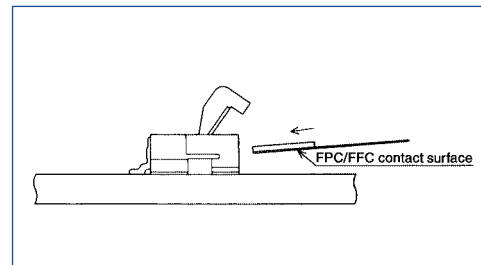

③

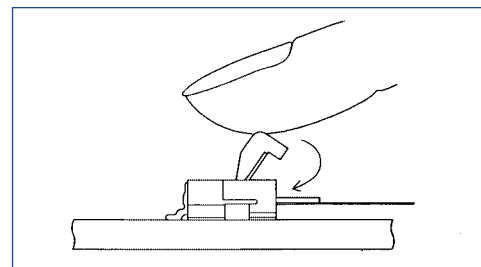

Product Specifications

Rating	Current rating: 0.5A DC(Note 1)	Operating Temperature Range: -40 to +70°C (Note 2)	Storage Temperature Range: -10 to +50°C (Note 3)
	Voltage rating: 50V AC	Operating Humidity Range: Relative humidity, 90% max. (Not dewed)	Storage Humidity Range: Relative humidity, 90% max. (Not dewed)

Applicable FPC	t=0.3±0.05 Gold plated	t=0.18 ± 0.05 for FH12F-*S-0.5SH
----------------	------------------------	----------------------------------

Item	Specification	Conditions
1. Insulation resistance	500M ohms minimum	100V DC
2. Withstanding voltage	No flashover or insulation breakdown.	150V AC/1 minute
3. Contact resistance	50m ohms maximum	1mA
4. Durability (Insertion/withdrawal)	Contact resistance: 50m ohms maximum No damage, cracks, or parts dislocation.	20 cycles
5. Vibration	No electrical discontinuity of 1μs or more Contact resistance: 50m ohms maximum. No damage, cracks, or parts dislocation.	Frequency: 10 to 55 Hz, single amplitude of 0.75 mm, 2 hours in each of the 3 directions.
6. Shock	No electrical discontinuity of 1μs or more Contact resistance: 50m ohms maximum. No damage, cracks, or parts dislocation.	Acceleration of 490 m/s ² , 11 ms duration, sine half-wave waveform, 3 cycles in each of the 3 axis.
7. Humidity(Steady state)	Contact resistance: 50m ohms maximum. Insulation resistance: 50M ohms minimum. No damage, cracks, or parts dislocation.	96 hours at 40°C and humidity of 90% to 95%
8. Temperature Cycle	Contact resistance: 50m ohms maximum. Insulation resistance: 50M ohms minimum. No damage, cracks, or parts dislocation.	Temperature: -40°C → 15 to 35°C → 85°C → 15 to 35°C, Time: 30 → 5 max. → 30 → 5 max.(minutes) 5 cycles
9. Resistance to Soldering heat	No deformation of components affecting performance.	Reflow: At the recommended temperature profile Manual soldering: 350±5°C for 3 seconds

Note 1: When passing the current through all of the contacts, use 70% of the current rating.

Note 2: Includes temperature rise caused by current flow.

Note 3: The term "storage" refers to products stored for long period of time prior to mounting and use. Operating Temperature Range and Humidity range covers nonconducting condition of installed connectors in storage, shipment or during transportation.

Material

Part	Material	Finish	Remarks
Insulator	Polyamide, LCP(60 pos.)	Color : Beige	UL94V-0
Actuator	PPS	Color : Dark brown	
Contact	Phosphor bronze	Gold plated	
Metal Fittings	Brass	Tin plated	

Ordering Information

FH12 **A** - **10** (**4**) - **S** **A** - **0.5** **SH** (**55**)
 ① ② ③ ④ ⑤ ⑥ ⑦ ⑧ ⑨

① Series Name : FH12	⑤ Contact alignment: Single
② Blank : standard type A : Top contact type S : Type with strengthened flip-lock actuator F : Type with 0.18mm FPC End Thickness	⑥ Eccentric direction: Blank : standard type A : Eccentric type
③ Standard type : Number of contacts Eccentric type : Number of contacts in 0.5mm housing	⑦ Contacts Pitch : 0.5mm, 1mm
④ Standard type : Blank Eccentric type : Number of contacts	⑧ Contact type SH : SMT horizontal mounting type SV : SMT vertical mounting type
	⑨ Plating specification (55) : Gold plated

FH12 Series 0.5mm and 1mm Pitch Connectors For FPC/FPC

Series Configuration

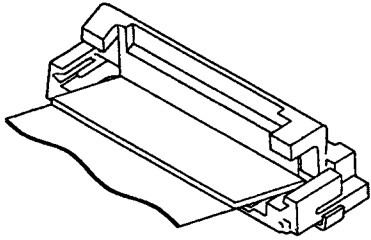
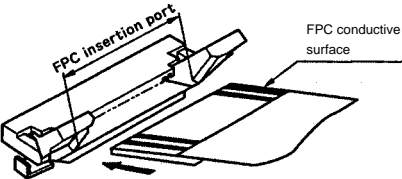
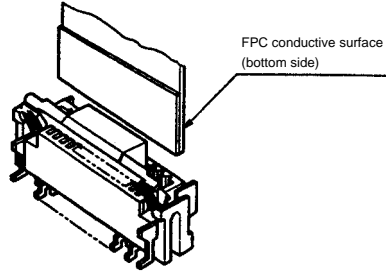
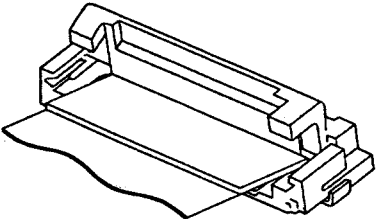
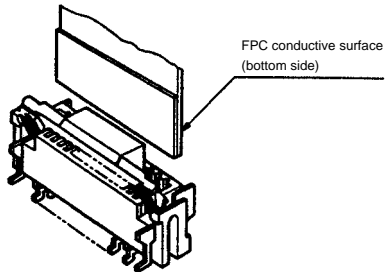
Pitch	Bottom Contact Type	Top Contact Type	Vertical mounting Type
0.5mm	 <p>FH12- ** S-0.5SH P.12 Number of contacts 6, 8, 10, 11, 12, 13, 14, 15, 16, 17, 18, 19, 20, 22, 24, 25, 26, 28, 30, 32, 33, 34, 35, 36, 40, 45, 50, 53</p>		
	<p>Type with Strengthened Lock Lever</p>		
	<p>FH12S- ** S-0.5SH P.13 Number of contacts 30, 40, 45, 50, 53</p>		
	<p>Type with 0.18mm FPC End Thickness</p>		
	<p>FH12F- ** S-0.5SH P.14 Number of contacts 6, 8, 10, 12, 13, 14, 15, 16, 18, 20, 22, 24, 25, 26, 28, 30, 32, 34, 36, 40</p>		
1mm			
	<p>Standard FH12- ** S-1SH P.18 Eccentric FH12- ** (***) SA-1SH Standard Number of contacts 5, 6, 7, 8, 9, 11, 12, 16, 17, 22, 26 Eccentric Number of contacts 4, 6, 8, 10, 11, 14, 19, 24</p>		

0.5mm Pitch Bottom Contact Type

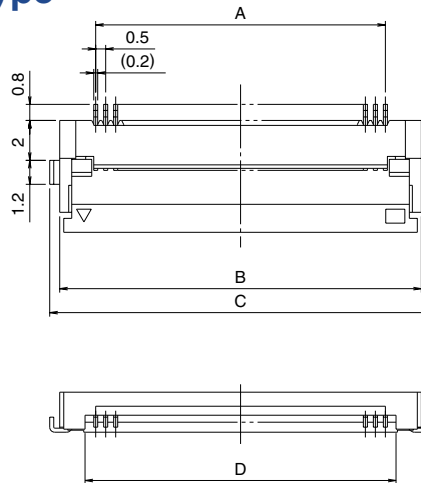

Mated Cross-sectional Diagram

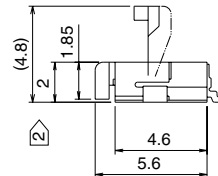
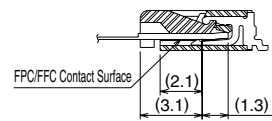

Unit:mm

Part Number	CL No.	Number of Contacts	A	B	C	D	RoHS
FH12- 6S-0.5SH(55)	586-0582-5-55	6	2.5	6.1	7.1	3.57	YES
FH12- 8S-0.5SH(55)	586-0744-5-55	8	3.5	7.1	8.1	4.57	
FH12-10S-0.5SH(55)	586-0522-3-55	10	4.5	8.1	9.1	5.57	
FH12-11S-0.5SH(55)	586-0600-5-55	11	5	8.6	9.6	6.07	
FH12-12S-0.5SH(55)	586-0704-0-55	12	5.5	9.1	10.1	6.57	
FH12-13S-0.5SH(55)	586-0549-0-55	13	6	9.6	10.6	7.07	
FH12-14S-0.5SH(55)	586-0533-0-55	14	6.5	10.1	11.1	7.57	
FH12-15S-0.5SH(55)	586-0523-6-55	15	7	10.6	11.6	8.07	
FH12-16S-0.5SH(55)	586-0531-4-55	16	7.5	11.1	12.1	8.57	
FH12-17S-0.5SH(55)	586-0606-1-55	17	8	11.6	12.6	9.07	
FH12-18S-0.5SH(55)	586-0530-1-55	18	8.5	12.1	13.1	9.57	
FH12-19S-0.5SH(55)	586-0534-2-55	19	9	12.6	13.6	10.07	
FH12-20S-0.5SH(55)	586-0524-9-55	20	9.5	13.1	14.1	10.57	
FH12-22S-0.5SH(55)	586-0532-7-55	22	10.5	14.1	15.1	11.57	
FH12-24S-0.5SH(55)	586-0521-0-55	24	11.5	15.1	16.1	12.57	
FH12-25S-0.5SH(55)	586-0692-3-55	25	12	15.6	16.6	13.07	
FH12-26S-0.5SH(55)	586-0576-2-55	26	12.5	16.1	17.1	13.57	
FH12-28S-0.5SH(55)	586-0612-4-55	28	13.5	17.1	18.1	14.57	
Note ② FH12-30S-0.5SH(55)	586-0525-1-55	30	14.5	18.1	19.1	15.57	
FH12-32S-0.5SH(55)	586-0681-7-55	32	15.5	19.1	20.1	16.57	
FH12-33S-0.5SH(55)	586-0520-8-55	33	16	19.6	20.6	17.07	
FH12-34S-0.5SH(55)	586-0617-8-55	34	16.5	20.1	21.1	17.57	
FH12-35S-0.5SH(55)	586-0740-4-55	35	17.0	20.6	21.6	18.07	
FH12-36S-0.5SH(55)	586-0526-4-55	36	17.5	21.1	22.1	18.57	
Note ② FH12-40S-0.5SH(55)	586-0527-7-55	40	19.5	23.1	24.1	20.57	
Note ② FH12-45S-0.5SH(55)	586-0528-0-55	45	22	25.6	26.6	23.07	
Note ② FH12-50S-0.5SH(55)	586-0529-2-55	50	24.5	28.1	29.1	25.57	
Note ② FH12-53S-0.5SH(55)	586-0595-7-55	53	26	29.6	30.6	27.07	

Note 1 : Embossed tape reel packaging (2,000 pieces/reel).
 Order by number of reels.

Note ② : If there is no problem with the connector height, we recommend the type with the strengthened Flip-lock actuator (FH12S-*S-0.5SH).
 Standard type connector height: 2 mm
 Connector height of type with strengthened Flip-lock actuator: 2.4 mm

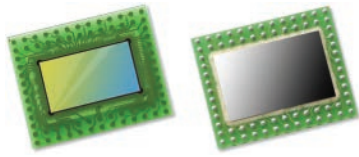

OS02C10 2-megapixel product brief



available in
a lead-free
package

Image Sensor Combines Ultra Low Light and Nyxel® NIR Technologies for Industry's Best Nighttime Camera Performance

OmniVision's OS02C10 is a 2.9-micron, 2-megapixel image sensor with breakthrough ultra-low-light (ULL) technology. Combining ULL with OmniVision's industry-leading Nyxel® near-infrared (NIR) technology, the OS02C10 works equally well in all lighting conditions. It can detect incident light in both visible and NIR wavelengths and produce precise color and monochrome images for security applications such as remote surveillance cameras with AI for accurate facial recognition.

Nyxel® NIR technology infuses the OS02C10 with exceptional quantum efficiency (QE) of 60% at 850 nm and 40% at 940 nm, which is 2x to 4x better than competing devices. This enables the use of lower-power IR illumination in total darkness, resulting in an estimated 3x reduction in system-level power consumption. Additionally, 940 nm NIR lighting cannot be detected by the human eye in dark indoor settings, while 850 nm light is ideal for outdoor security cameras. The OS02C10's ability to capture crisp, clear images using undetectable 940 nm NIR light means that indoor security cameras will not disturb sleeping occupants, and can be easily concealed from intruders.

The amount of NIR light that a sensor requires to capture high-quality images can be quantified with a new metric called NIR SNR1, which takes into account the QE, pixel size and read noise. The OS02C10 achieves an SNR_{1850nm} of 23 nW/cm² and an SNR_{1940nm} of 31 nW/cm², which means designers can reduce IR illumination to consume 2x to 4x less power compared to the competitors' sensors, for the same environment and over the same image-detection range.

The OS02C10 has a superior low-noise design, achieving an SNR1 of 0.16 lux while producing high definition 1080p images. OmniVision's proprietary dual-conversion-gain technology allows this sensor to achieve the industry's best ULL performance, while the 3-frame staggered shutter minimizes motion artifacts and enables a high dynamic range (HDR) of 120 dB. Additionally, these technologies are easily upgradable to 2K and 4K resolution as security systems begin their transition to higher-quality displays.

Find out more at www.ovt.com.



OmniVision.

Applications

- Security Camera
- High Resolution Consumer Camera
- Action Camera

Product Features

- QE enhancement in NIR range
- support for image size:
 - 1920 x 1080
 - VGA
 - QVGA, and any cropped size
- high dynamic range
- high sensitivity
- programmable conversion gain
- image sensor processor functions:
 - defective pixel cancellation
 - automatic black level correction, etc.
- pixel data: 12b RAW RGB
- SCCB for register programming
- programmable GPIOs
- high speed serial data transfer with MIPI CSI-2 or LVDS
- external frame synchronization capability
- embedded temperature sensor
- one time programmable (OTP) memory

OS02C10

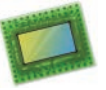

Ordering Information

- OS02C10-J70A-Z (color, lead-free)
70-pin fan-out package

Product Specifications

- active array size: 1920 x 1080
- maximum image transfer rate:
 - 40X3 fps @ 1080p in 10-bit
 - 30X3 fps @ 1080p in 12-bit
- power supply:
 - analog: 2.8V
 - digital: 1.1V
 - I/O pins: 1.8V
- temperature range:
 - operating: -30°C to +85°C junction temperature
- output interfaces:
 - up to 4-lane MIPI CSI-2 or LVDS
- lens size: 1/2.8"
- lens chief ray angle: 9° linear
- output formats: linear output, dual exposure HDR (long and short), 3-exposure HDR (long, short, and very short), conversion gain programmable in each channel
- scan mode: progressive
- shutter: rolling shutter
- pixel size: 2.9 μm x 2.9 μm
- image area: 5614.4 μm x 3178.4 μm

Functional Block Diagram

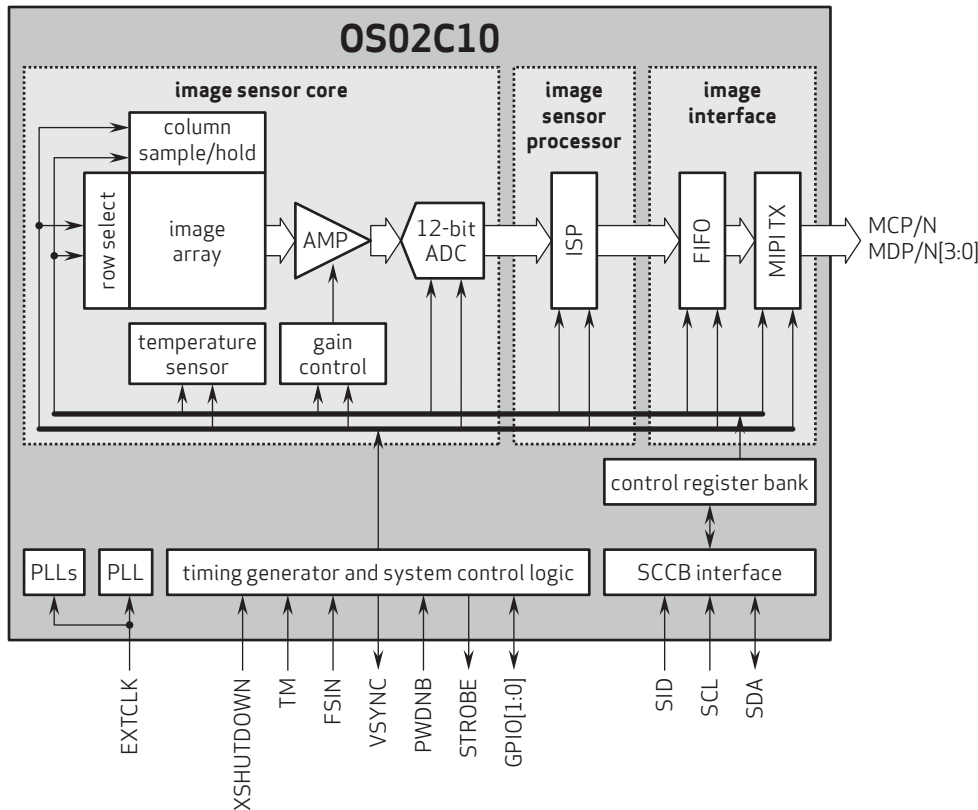

4275 Burton Drive
Santa Clara, CA 95054
USA

Tel: +1 408 567 3000
Fax: +1 408 567 3001
www.ovt.com

OmniVision reserves the right to make changes to their products or to discontinue any product or service without further notice. OmniVision, the OmniVision logo, and Nyxel are registered trademarks of OmniVision Technologies, Inc. All other trademarks are the property of their respective owners.



OmniVision



Camera Module Pinout Definition Reference Chart

OmniVision	Sony	Samsung	On-Semi	Aptina	Himax	GalaxyCore	PixArt	SmartSens	Sensors	
Pin Signal										
Description										
DGND GND										ground for digital circuit
AGND										ground for analog circuit
PCLK DCK										DVP PCLK output
XCLR PWDN XSHUTDOWN STANDBY										power down active high with internal pull-down resistor
MCLK XVCLK XCLK INCK										system input clock
RESET RST										reset active low with internal pull-up resistor
NC NULL										no connect
SDA SIO_D SIOD										SCCB data
SCL SIO_C SIOC										SCCB input clock
VSYNC XVS FSYNC										DVP VSYNC output
HREF XHS										DVP HREF output
DOVDD										power for I/O circuit
AFVDD										power for VCM circuit
AVDD										power for analog circuit
DVDD										power for digital circuit
STROBE FSTROBE										strobe output
FSIN										synchronize the VSYNC signal from the other sensor
SID										SCCB last bit ID input
ILPWM										mechanical shutter output indicator
FREQ										frame exposure / mechanical shutter
GPIO										general purpose inputs
SLASEL										I2C slave address select
AFEN										CEN chip enable active high on VCM driver IC
MIPI Interface										
MDN0 DN0 MD0N DATA_N DMO1N										MIPI 1st data lane negative output
MDP0 DP0 MD0P DATA_P DMO1P										MIPI 1st data lane positive output
MDN1 DN1 MD1N DATA2_N DMO2N										MIPI 2nd data lane negative output
MDP1 DP1 MD1P DATA2_P DMO2P										MIPI 2nd data lane positive output
MDN2 DN2 MD2N DATA3_N DMO3N										MIPI 3rd data lane negative output
MDP2 DP2 MD2P DATA3_P DMO3P										MIPI 3rd data lane positive output
MDN3 DN3 MD3N DATA4_N DMO4N										MIPI 4th data lane negative output
MDP3 DP3 MD3P DATA4_P DMO4P										MIPI 4th data lane positive output
MCN CLKN CLK_N DCKN										MIPI clock negative output
MCP CLKP MCP CLK_P DCKN										MIPI clock positive output
DVP Parallel Interface										
D0 DO0 Y0										DVP data output port 0
D1 DO1 Y1										DVP data output port 1
D2 DO2 Y2										DVP data output port 2
D3 DO3 Y3										DVP data output port 3
D4 DO4 Y4										DVP data output port 4
D5 DO5 Y5										DVP data output port 5
D6 DO6 Y6										DVP data output port 6
D7 DO7 Y7										DVP data output port 7
D8 DO8 Y8										DVP data output port 8
D9 DO9 Y9										DVP data output port 9
D10 DO10 Y10										DVP data output port 10
D11 DO11 Y11										DVP data output port 11



your BEST camera module partner

Cameras Applications

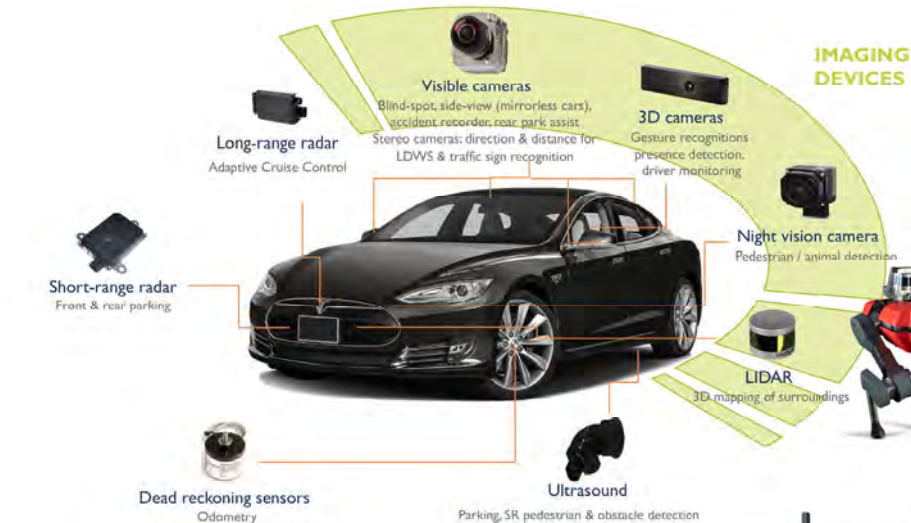



Camera Reliability Test

Reliability Inspection Item		Testing Method	Acceptance Criteria	
Category	Item			
Environmental	Storage Temperature	High 60°C 96 Hours	Temperature Chamber	No Abnormal Situation
		Low -20°C 96 Hours	Temperature Chamber	No Abnormal Situation
	Operation Temperature	High 60°C 24 Hours	Temperature Chamber	No Abnormal Situation
		Low -20°C 24 Hours	Temperature Chamber	No Abnormal Situation
	Humidity	60°C 80% 24 Hours	Temperature Chamber	No Abnormal Situation
	Thermal Shock	High 60°C 0.5 Hours Low -20°C 0.5 Hours Cycling in 24 Hours	Temperature Chamber	No Abnormal Situation
Physical	Drop Test (Free Falling)	Without Package 60cm	10 Times on Wood Floor	Electrically Functional
		With Package 60cm	10 Times on Wood Floor	Electrically Functional
	Vibration Test	50Hz X-Axis 2mm 30min	Vibration Table	Electrically Functional
		50Hz Y-Axis 2mm 30min	Vibration Table	Electrically Functional
		50Hz Z-Axis 2mm 30min	Vibration Table	Electrically Functional
	Cable Tensile Strength Test	Loading Weight 4 kg 60 Seconds Cycling in 24 Hours	Tensile Testing Machine	Electrically Functional
Electrical	ESD Test	Contact Discharge 2 KV	ESD Testing Machine	Electrically Functional
		Air Discharge 4 KV	ESD Testing Machine	Electrically Functional
	Aging Test	On/Off 30 Seconds Cycling in 24 Hours	Power Switch	Electrically Functional
	USB Connector	On/Off 250 Times	Plug and Unplug	Electrically Functional





Inspection Item		Inspection Method	Standard of Inspection		
Category	Item				
Appearance	FPC/ PCB	Color	The Naked Eye	Major Difference is Not Allowed.	
		Be Torn/Chopped	The Naked Eye	Copper Crack Exposure is Not Allowed.	
		Marking	The Naked Eye	Clear, Recognizable (Within 30cm Distance)	
	Holder	Scratches	The Naked Eye	The Inside Crack Exposure is Not Allowed	
		Gap	The Naked Eye	Meet the Height Standard	
		Screw	The Naked Eye	Make Sure Screws Are Presented (If Any)	
		Damage	The Naked Eye	The Inside Crack Exposure is Not Allowed	
	Lens	Scratch	The Naked Eye	No Effect On Resolution Standard	
		Contamination	The Naked Eye	No Effect On Resolution Standard	
		Oil Film	The Naked Eye	No Effect On Resolution Standard	
		Cover Tape	The Naked Eye	No Issue On Appearance.	
	Function	Image	No Communication	Test Board	Not Allowed
			Bright Pixel	Black Board	Not Allowed In the Image Center
Dark Pixel			White board	Not Allowed In the Image Center	
Blurry			The Naked Eye	Not Allowed	
No Image			The Naked Eye	Not Allowed	
Vertical Line			The Naked Eye	Not Allowed	
Horizontal Line			The Naked Eye	Not Allowed	
Light Leakage			The Naked Eye	Not Allowed	
Blinking Image			The Naked Eye	Not Allowed	
Bruise			Inspection Jig	Not Allowed	
Resolution			Chart	Follows Outgoing Inspection Chart Standard	
Color			The Naked Eye	No Issue	
Noise			The Naked Eye	Not Allowed	
Corner Dark			The Naked Eye	Less Than 100px By 100px	
Color Resolution			The Naked Eye	No Issue	
Dimension	Height	The Naked Eye	Follows Approval Data Sheet		
	Width	The Naked Eye	Follows Approval Data Sheet		
	Length	The Naked Eye	Follows Approval Data Sheet		
	Overall	The Naked Eye	Follows Approval Data Sheet		



KLT Package Solutions

KLT Camera Module

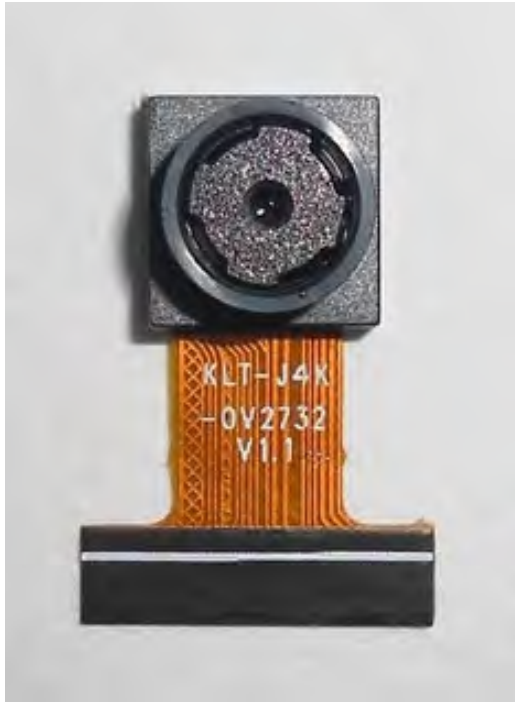

Complete with Lens Protection Film



Tray with Grid and Space



Place Cameras on the Tray

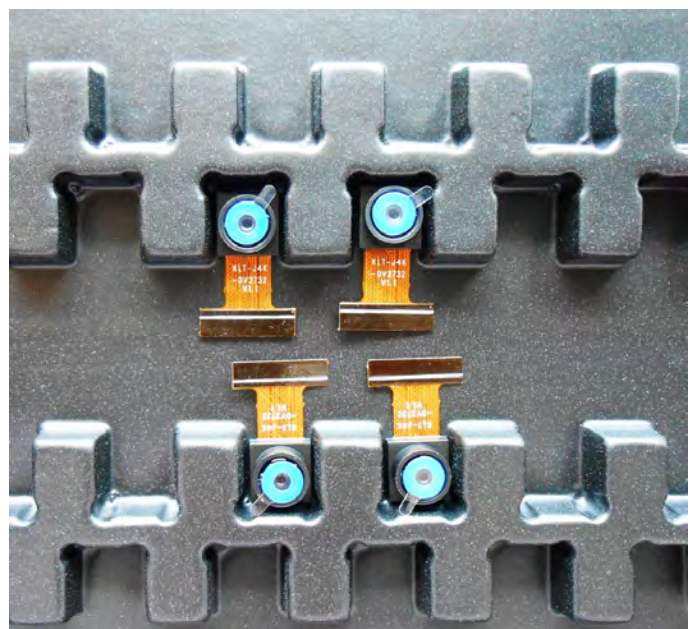



Camera Modules Package Solution

Full Tray of Cameras



Cover Tray with Lid



Put Tray into Anti-Static Bag



Vacuum the Anti-Static Bag

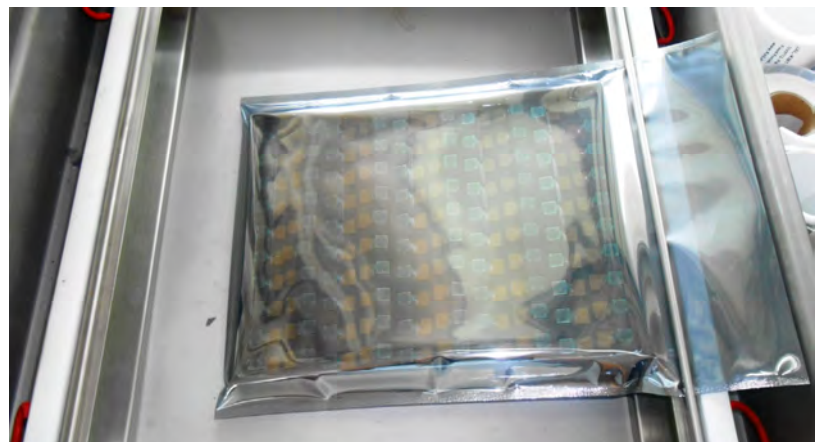



Camera Modules Package Solution

Sealed Vacuum Bag with Labels

1. Model and Description 2. Quantity 3. Shipping Date 4. Caution





Large Order Package Solution

Place Foam Sheets Between Trays



Foam Sheets are Slightly Larger than Trays



Place Foam Sheets and Trays into Box



Foam Sheets are Tightly Fitting Box





Small Order Package Solution

Place Foam Sheets and Trays into Small Box



Foam Sheets are Nicely Fitting the Small Box



Package in Small Box for Shipment



Place Small Boxes into Larger Box





Carbon Box Package Solution

Seal the Carbon Box

Final Package Labelled Box



Carbon Box Ready for Shipment

1. Delivery Address and Phone No. 2. Box No. and Ship Date 3. Fragile Caution





Sample Order Package Solution

Place Sample into Small Anti-Static Bag



Place Connectors into Small Ant-Static Bag



Sample Labels on the Small Bag

1. Camera Module or Connector Model
2. Shipping Date and Quantity
3. Caution





Connectors Large Order Package Solution

Connectors in a Wheel



Label Connectors in the Wheel



The Wheel is Perfectly Fitting the Box



Connectors Box Ready for Shipment





Company Kai Lap Technologies (KLT)

Kai Lap Technologies Group Limited. (KLT) was established in 2009, a next-generation technology driven manufacturer specialized in research, design, and produce of audio and video products. KLT is occupying 20,000 square feet automated plants with 100 employees of annual throughput 30,000,000 units cameras.

KLT provides OEM, ODM design, contract manufacturing, and builds the camera products. You may provide the requirements to us, even with a hand draft, our sales and engineering work together to meet your needs. We consider ourselves your last-term partner in developing practical and innovative solutions.

Our team covers everything from initial concept development to mass produced product. KLT specializes in customized camera design, raw material, electronic engineering, firmware/software development, product testing, and packing design. Our experienced strategic supply systems offer a robust and dependable manufacturing capacity for orders of various sizes.

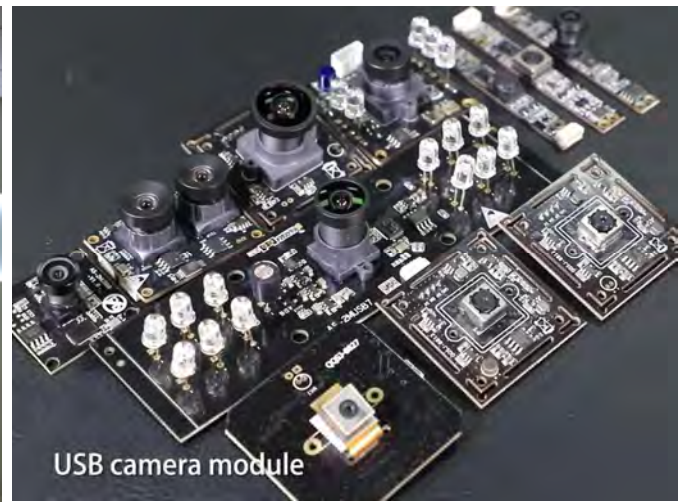

Limited Warranty

KLT provides the following limited warranty if you purchased the Product(s) directly from KLT company or from KLT's website, www.KaiLapTech.com. Product(s) purchased from other sellers or sources are not covered by this Limited Warranty. KLT guarantees that the Product(s) will be free from defects in materials and workmanship under normal use for a period of one (1) year from the date you receive the product ("Warranty Period").

For all Product(s) that contain or develop material defects in materials or workmanship during the Warranty Period, KLT will, at its sole option, either: (i) repair the Product(s); (ii) replace the Product(s) with a new or refurbished Product(s) (replacement Product(s) being of identical model or functional equivalent); or (iii) provide you a refund of the price you paid for the Product(s).

This Limited Warranty of KLT is solely limited to repair and/or replacement on the terms set forth above. KLT is not reliable or responsible for any subsequent events.





CMOS CAMERA MODULES



your BEST camera module partner

KLT Strength

Powerful Factory



Professional Service



Promised Delivery



www.KaiLapTech.com sales@KaiLapTech.com Tel: (852) 6908 1256 Fax: (852) 3017 6778

All rights reserved @ Kai Lap Technologies Group Ltd. Specifications subject to change without notice.